

Article number: 0118033

Description: Retaining ring H 17

Measures

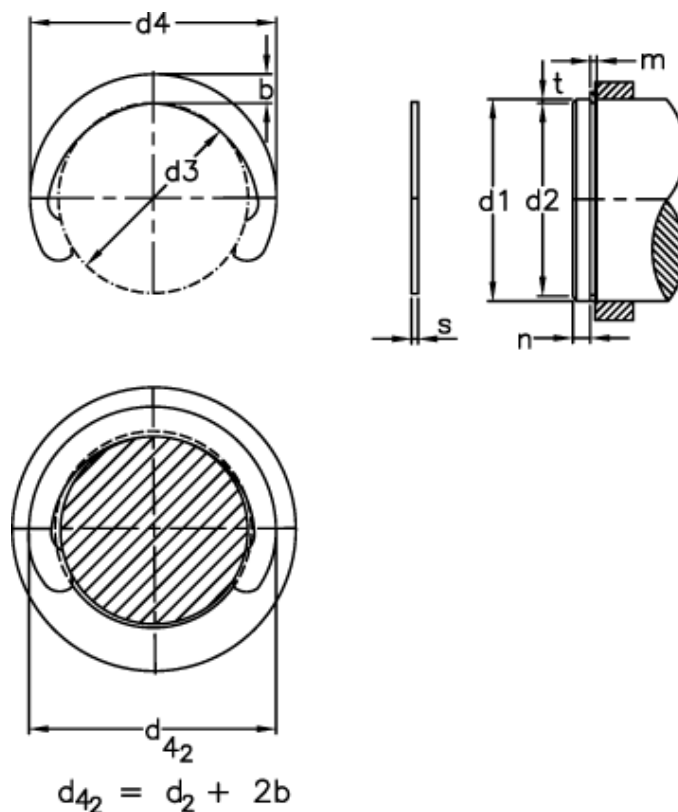

b	= 2.25	FRg kN	= 2.0	t	= 0.80
d1	= 17	FR kN	= 6.00	tol	= -0.11
d2	= 15.4	g	= 1.00	tol	= 0.18
d3	= 14.90	Gripper	= GRH 17	tol	= -0.06
d4	= 19.40	m min	= 1.10	Weight kg/1000	= 0.64
d4 2	= 19.9	n abl x 1000	= 23		
Description	= H 17,0	Nominal drive	= 2.4		
FN kN	= 3.40	s	= 1.00		